

MVHB-500 系列

手動閥



規格

型號	MVHB-500(V)-4TV	MVHB-500(V)-4TV*-SP
	配管口徑代號	15A
配管口徑尺寸	Rc1/2	
方口數	5 口	
位置數	2 位置	3 位置
使用流體	空氣	
使用壓力範圍	0~1.2 MPa	
有效斷面積	41 mm ²	
周圍溫度	-5~+60°C (不凍結)	
重量	519 g	560 g

訂購代號

MVHB - 500V - 4TVC - SP - G

型號

本體寬度

4: 4 方向
(5 方口)

彈簧復歸型

配管口螺牙

無: 標準型
V: 直立型

無: 5 口 2 位
C: 中間位置關閉 (5 口 3 位)
P: 中間位置通氣 (5 口 3 位)
R: 中間位置排氣 (5 口 3 位)

無: Rc 牙
G: G 牙
NPT: NPT 牙

*V 型可搭配 MVSE-500 連座使用 (請參 1-41 頁)

MVHB-500-4TV

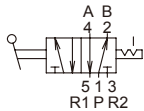

MVHB-500-4TVC

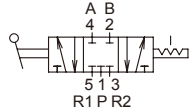

MVHB-500-4TVP

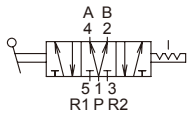

MVHB-500-4TVR

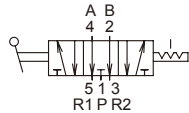

MVHB-500-4TV-SP

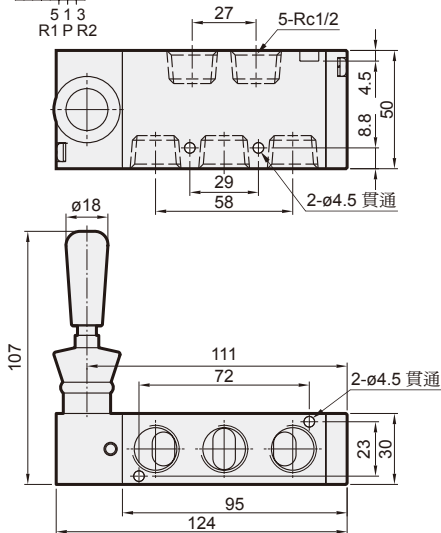
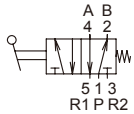

MVHB-500-4TVC-SP

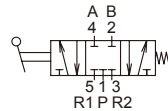

MVHB-500-4TVP-SP

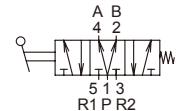

MVHB-500-4TVR-SP

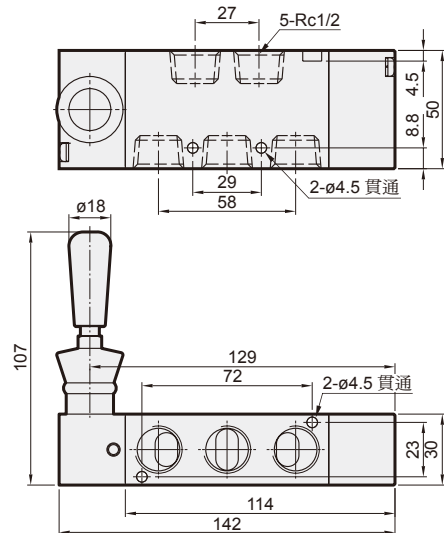
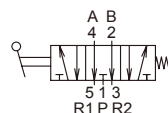

MVHB-500 外觀尺寸

手動閥



MVHB-500V-4TV

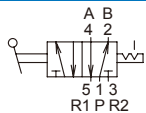

MVHB-500V-4TVC

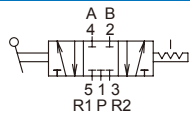

MVHB-500V-4TVP

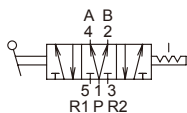

MVHB-500V-4TVR

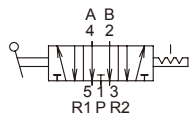

MVHB-500V-4TV-SP

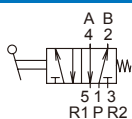

MVHB-500V-4TVC-SP

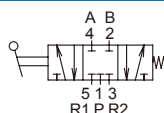

MVHB-500V-4TVP-SP

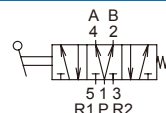

MVHB-500V-4TVR-SP

